

ОКТАВИА

Стежка

СТЛ.285.01

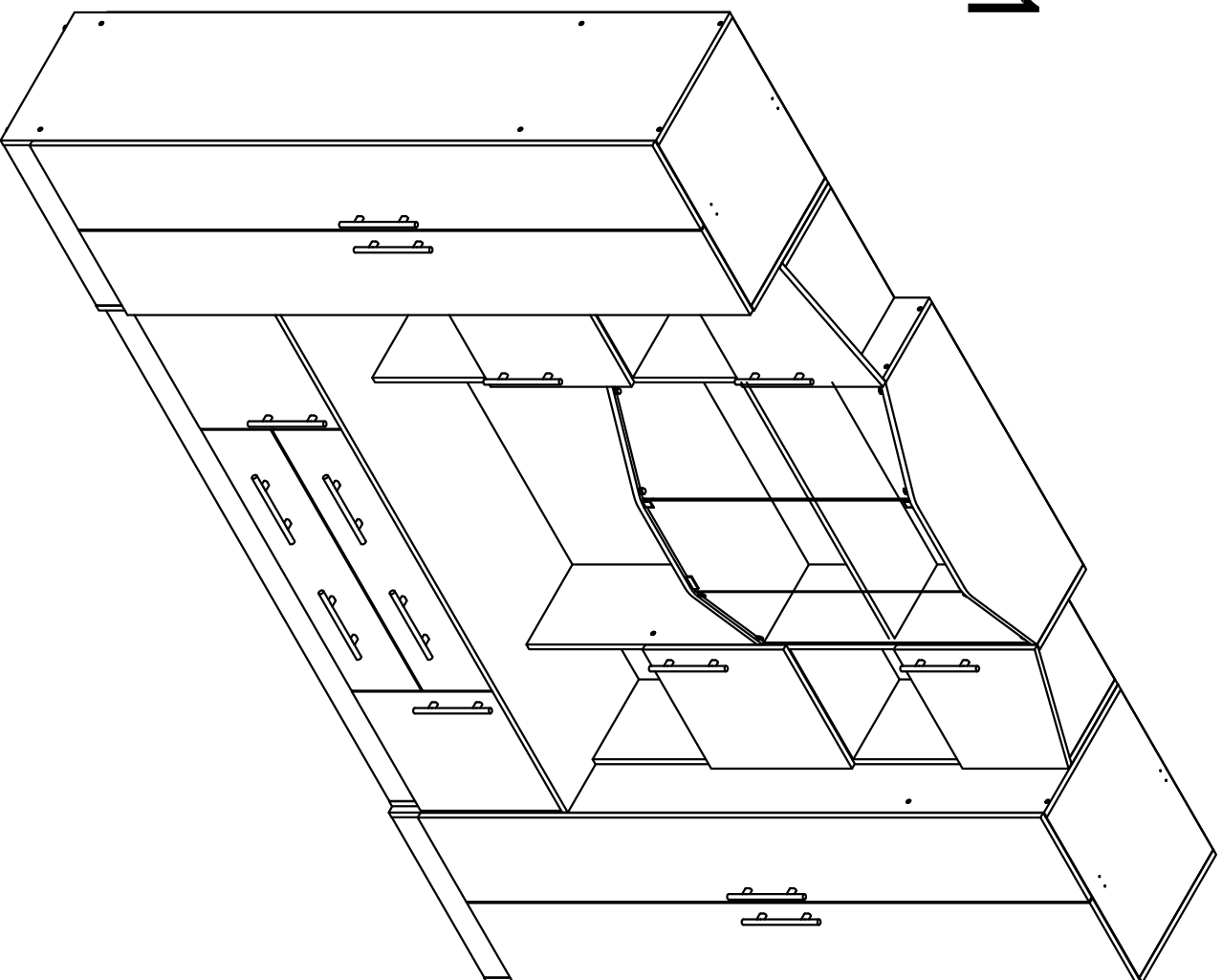
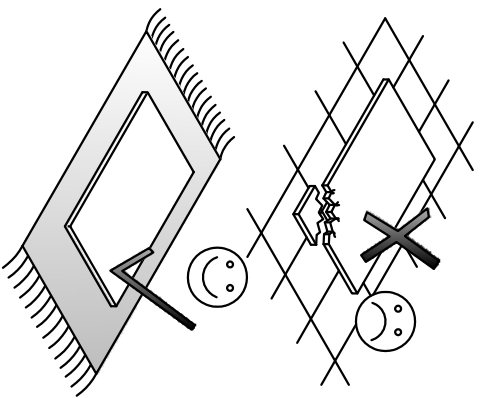

ОКТАВИЯ

Стенка

СТЛ.285.01

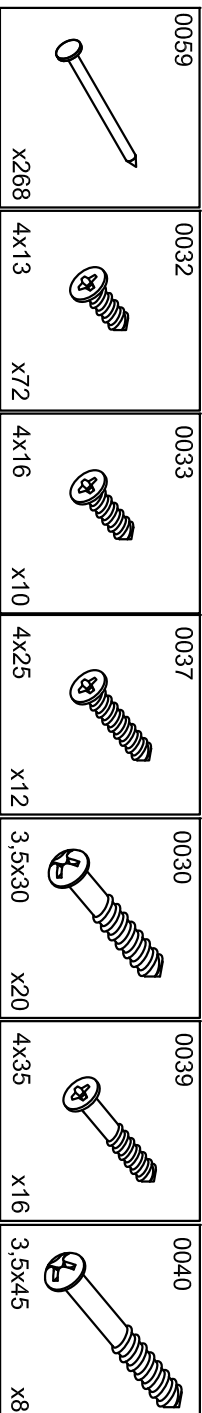
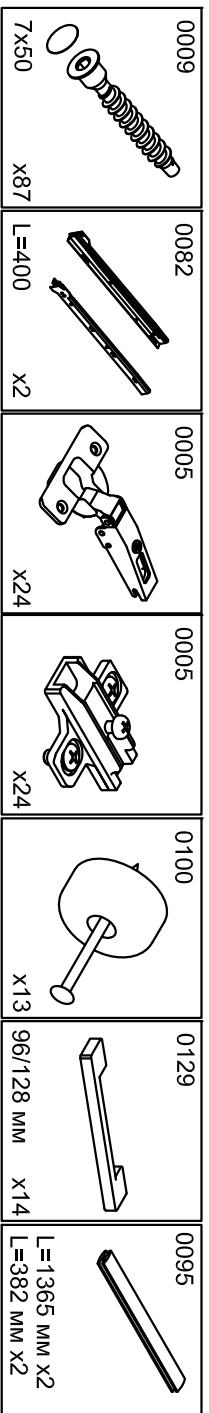
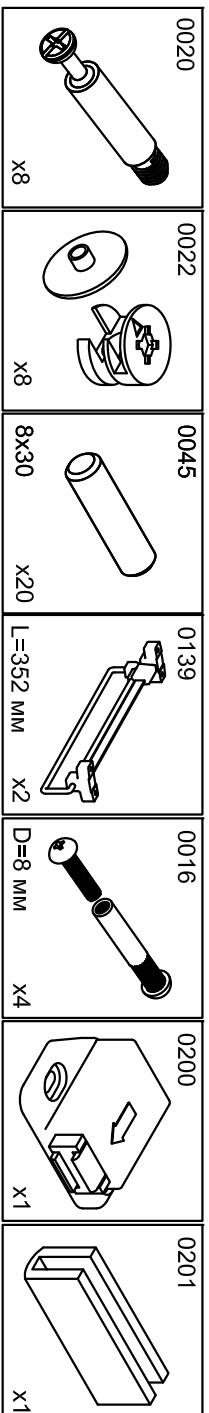
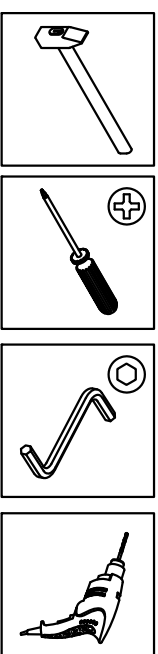
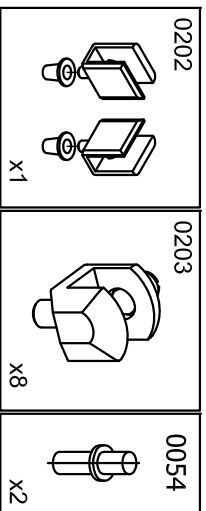
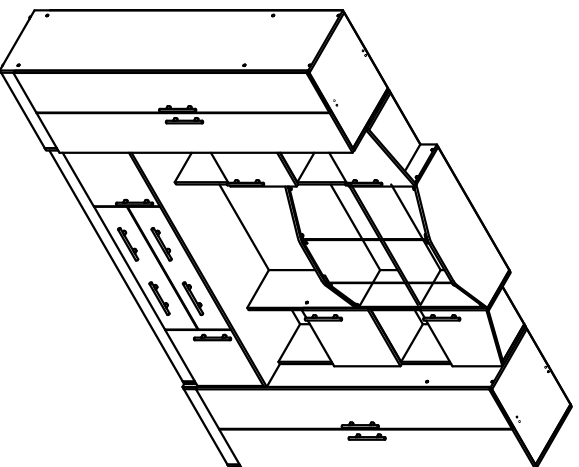
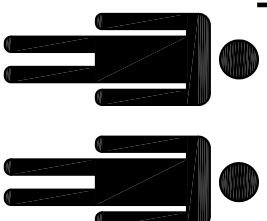

№	Размеры	Кол.	Пакет
1	1888x426x16	2	Пакет 1
2	1888x426x16	2	Пакет 1
3	1372x266x16	2	Пакет 4
4	1472x266x16	2	Пакет 4
5	500x406x16	1	Пакет 2
6	500x406x16	1	Пакет 2
7	396x406x16	1	Пакет 2
8	396x406x16	1	Пакет 2
9	534x426x16	6	Пакет 1
10	366x266x16	8	Пакет 4
11	1636x406x16	1	Пакет 2
12	872x380x16	1	Пакет 3
13	872x246x16	1	Пакет 3
14	872x380x16	1	Пакет 3
15	1794x388x3	2	Пакет 1
16	1794x280x3	4	Пакет 4
17	888x426x3	1	Пакет 1
18	888x376x3	1	Пакет 1
19	1670x426x16	1	Пакет 2
20	534x88x16	2	Пакет 2
21	1636x88x16	1	Пакет 2
22	1794x280x16	4	Пакет 4
23	406x396x16	4	Пакет 2
24	406x396x16	1	Пакет 2
25	406x396x16	1	Пакет 2
26	768x302x4	3	Пакет 5
27	868x201x16	2	Пакет 3
28	400x140x16	4	Пакет 1
29	816x124x16	2	Пакет 2
30	816x124x16	2	Пакет 2
31	830x398x3	2	Пакет 2

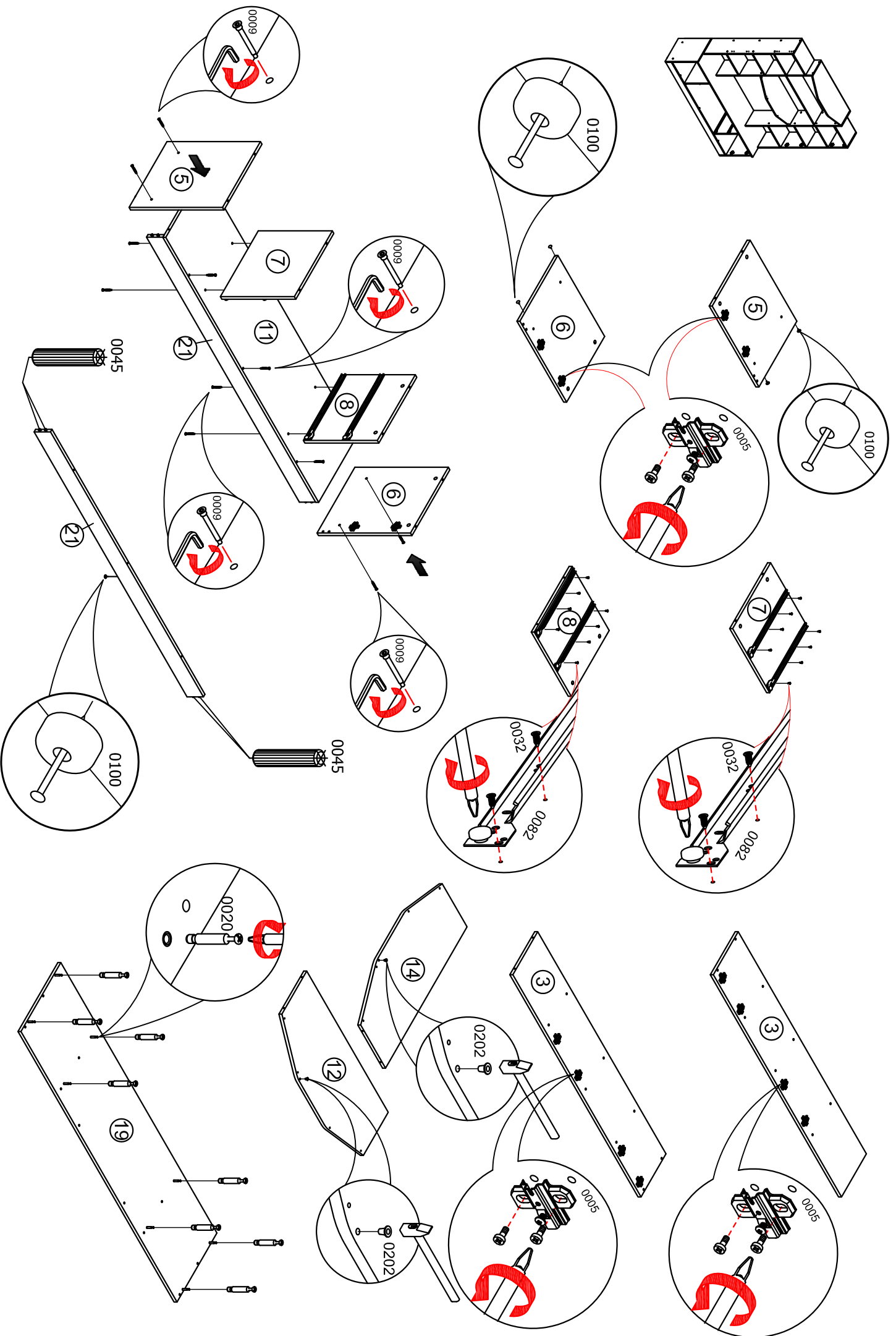
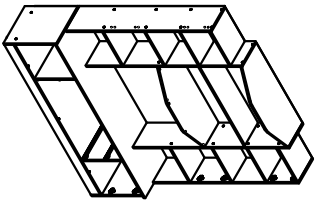

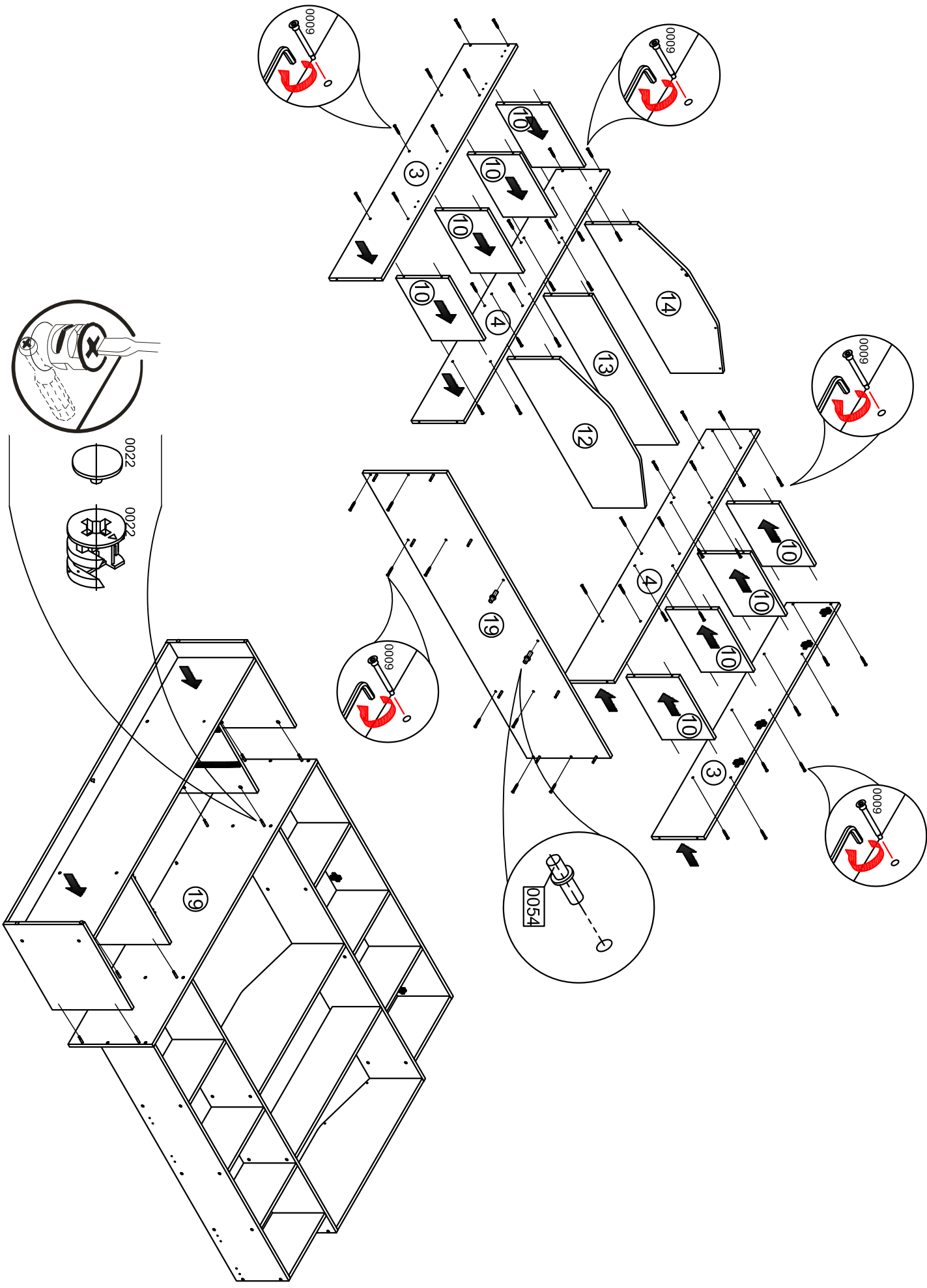

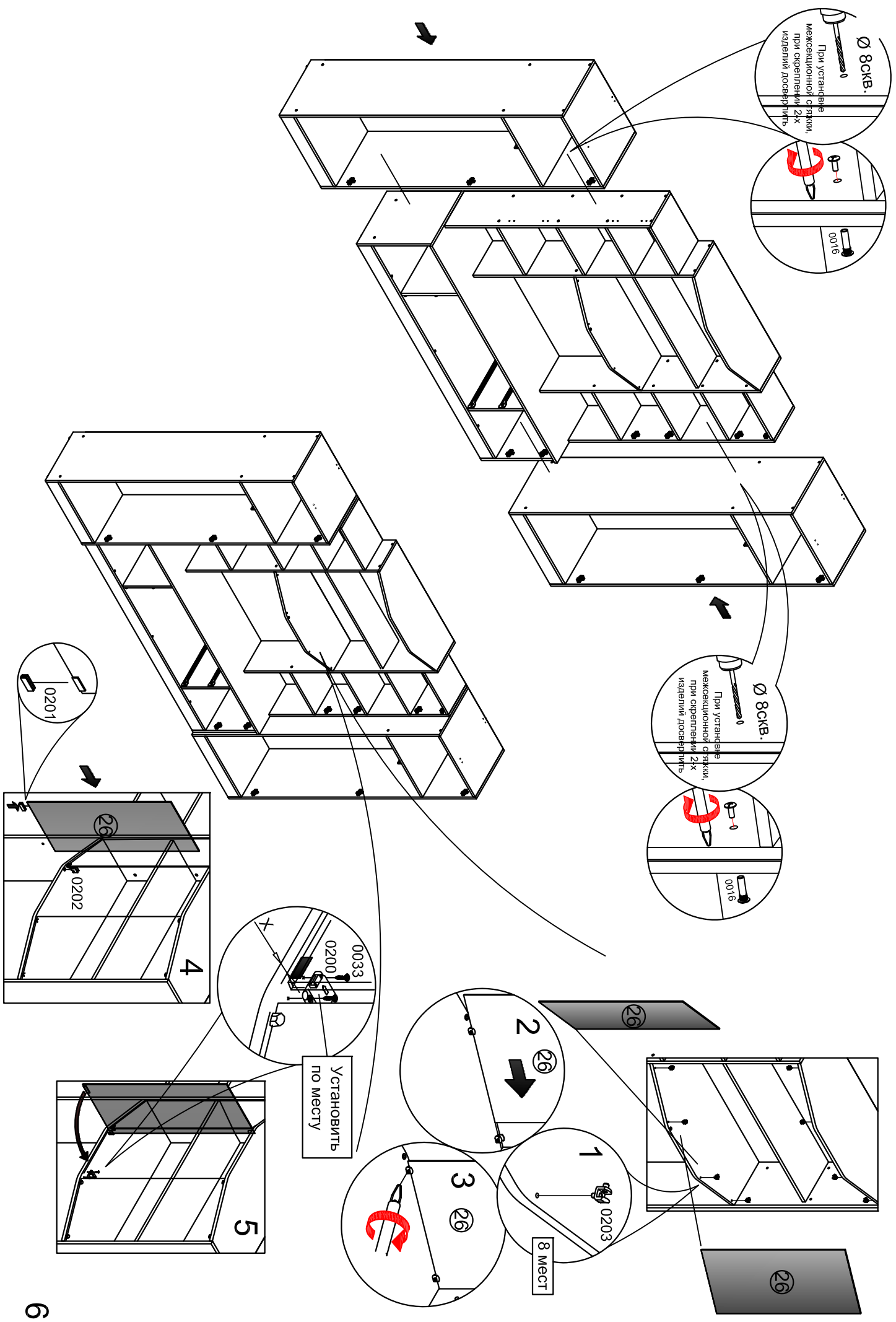

Ø 8 СВ.
0
При установке межсекционной стяжки, при срезании 2х изделий довернуть

0016

Ø 8 СВ.
0
При установке межсекционной стяжки, при срезании 2х изделий довернуть

0016

0033
0200
Установить по месту

26
26
26
1
0203
8 мест

0201
26
0202
4

5

