

# Шкаф 4-х дверный "ТИФАНИ" СТЛ.305.15

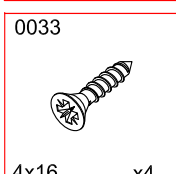

| Поз | Размер      | Кол-во | Упаковка |
|-----|-------------|--------|----------|
| 1   | 416x552x16  | 1      | пакет 2  |
| 2   | 978x552x16  | 1      | пакет 2  |
| 3   | 978x575x16  | 1      | пакет 2  |
| 4   | 1058x625x16 | 1      | пакет 2  |
| 5   | 978x80x16   | 1      | пакет 2  |
| 6   | 977x552x16  | 1      | пакет 2  |
| 7   | 1972x606x24 | 1      | пакет 1  |

| Поз | Размер      | Кол-во | Упаковка |
|-----|-------------|--------|----------|
| 8   | 1972x606x24 | 1      | пакет 1  |
| 9   | 1904x503x3  | 2      | пакет 1  |
| 10  | 1446x480x20 | 2      | пакет 3  |
| 11  | 418x480x20  | 1      | пакет 3  |
| 12  | 418x480x20  | 1      | пакет 3  |

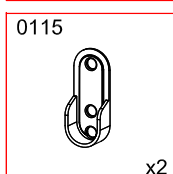
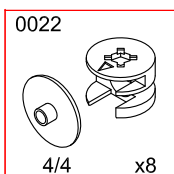
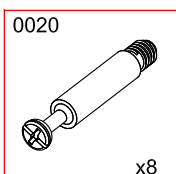
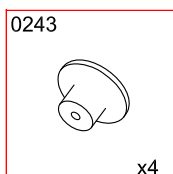
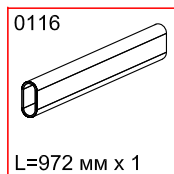
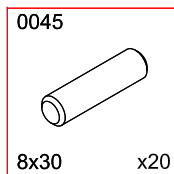
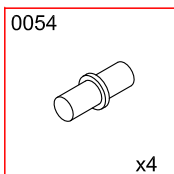
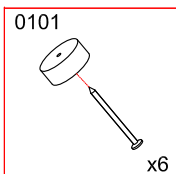
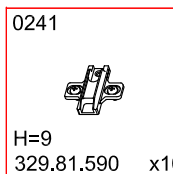
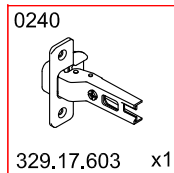
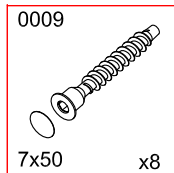
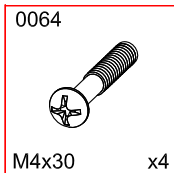
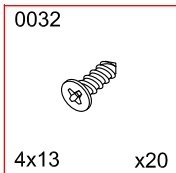
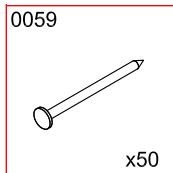
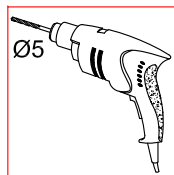
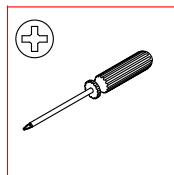
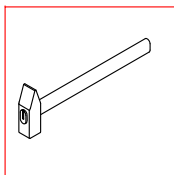
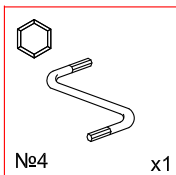
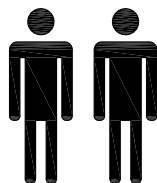
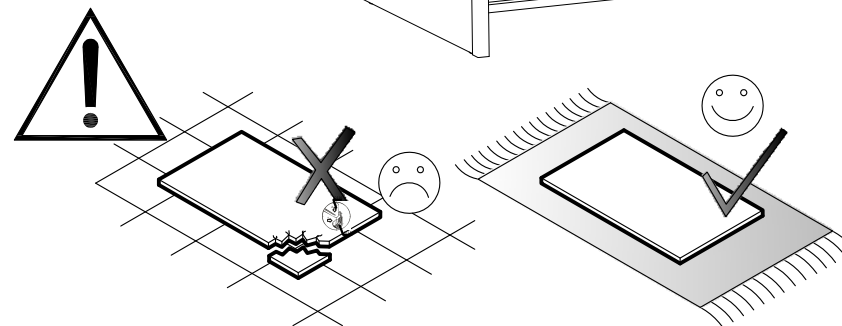
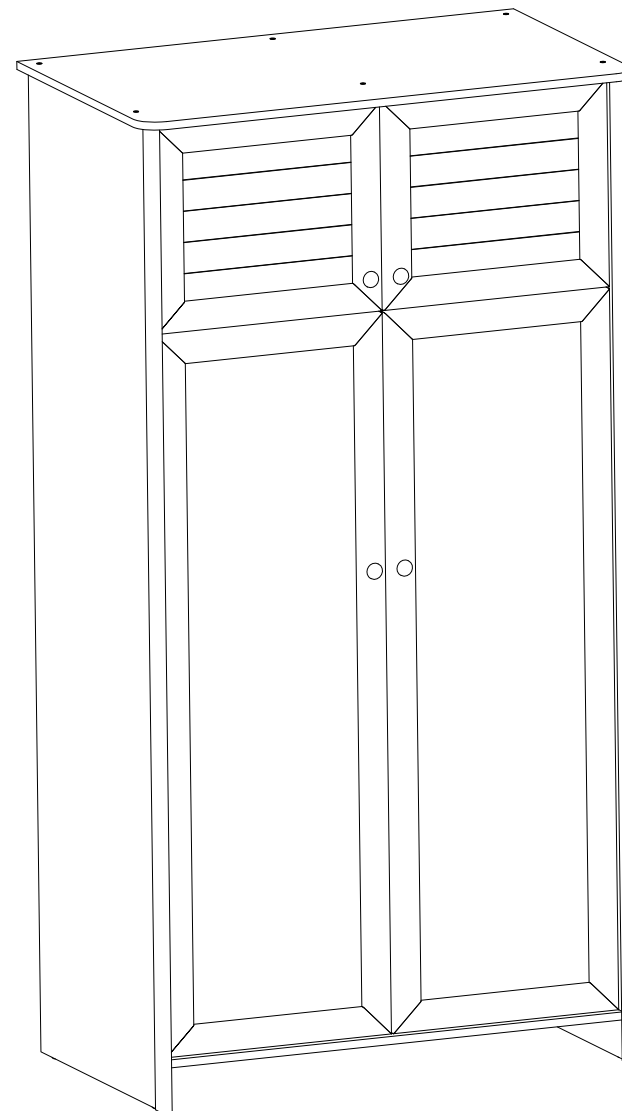

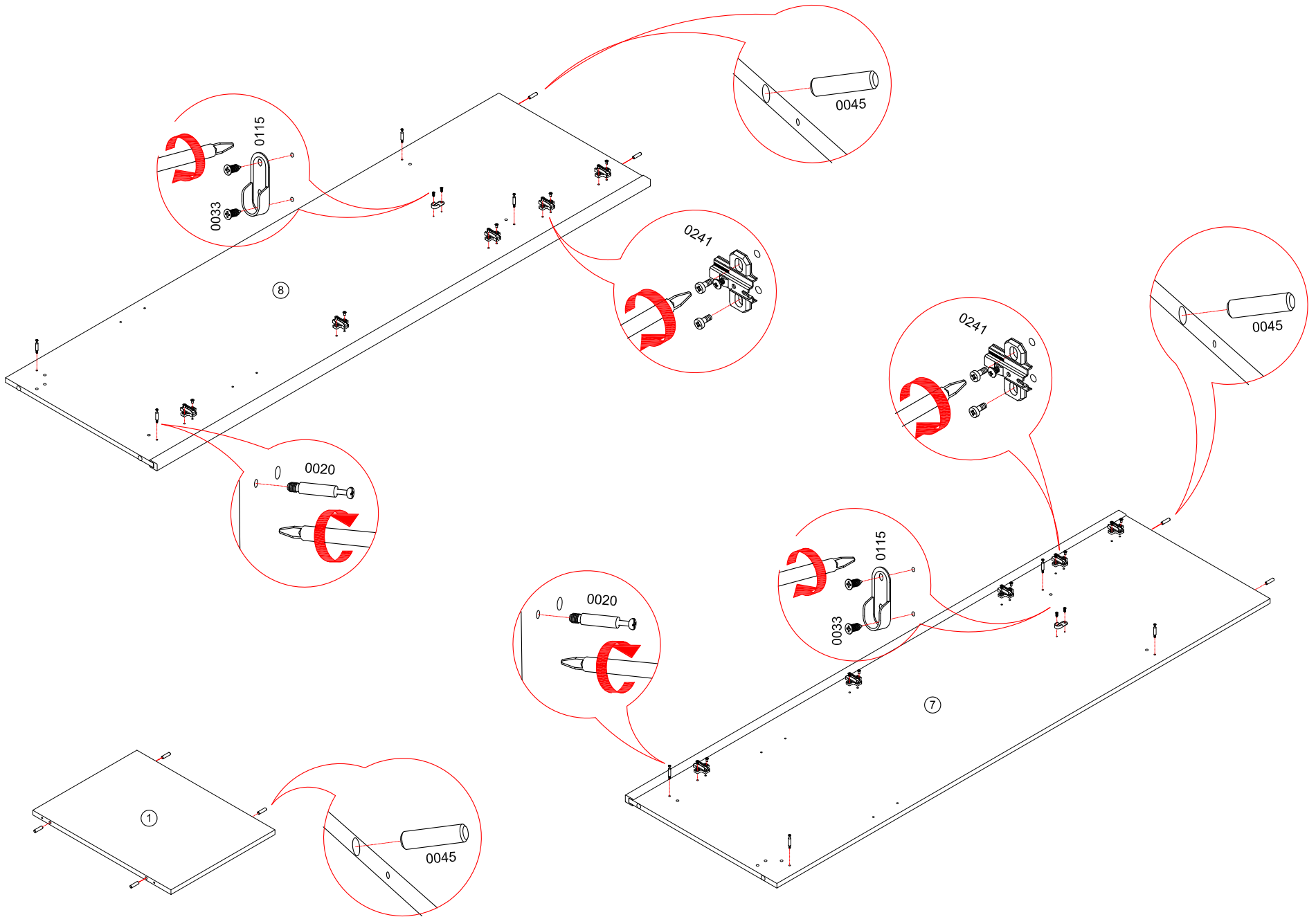

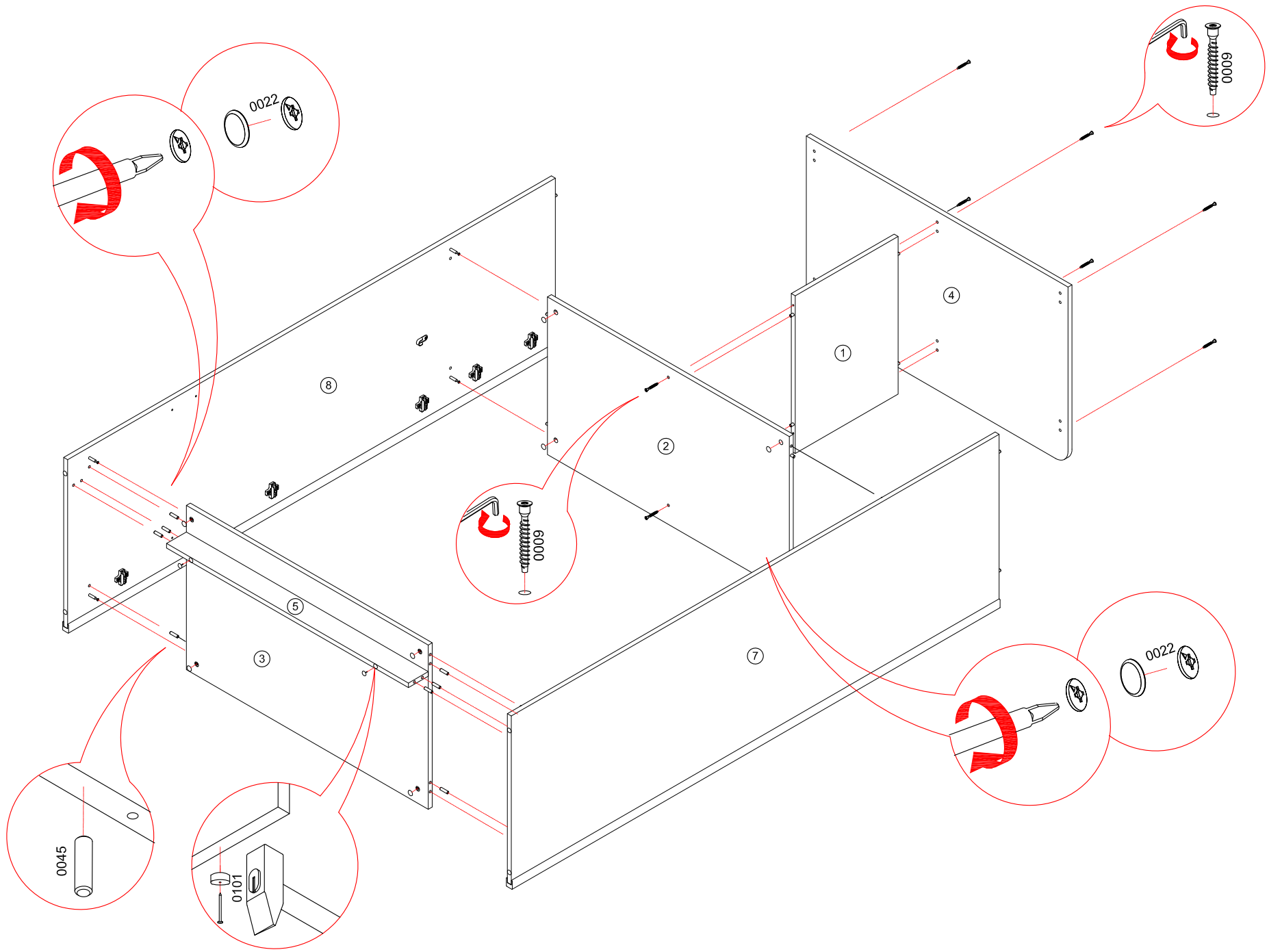

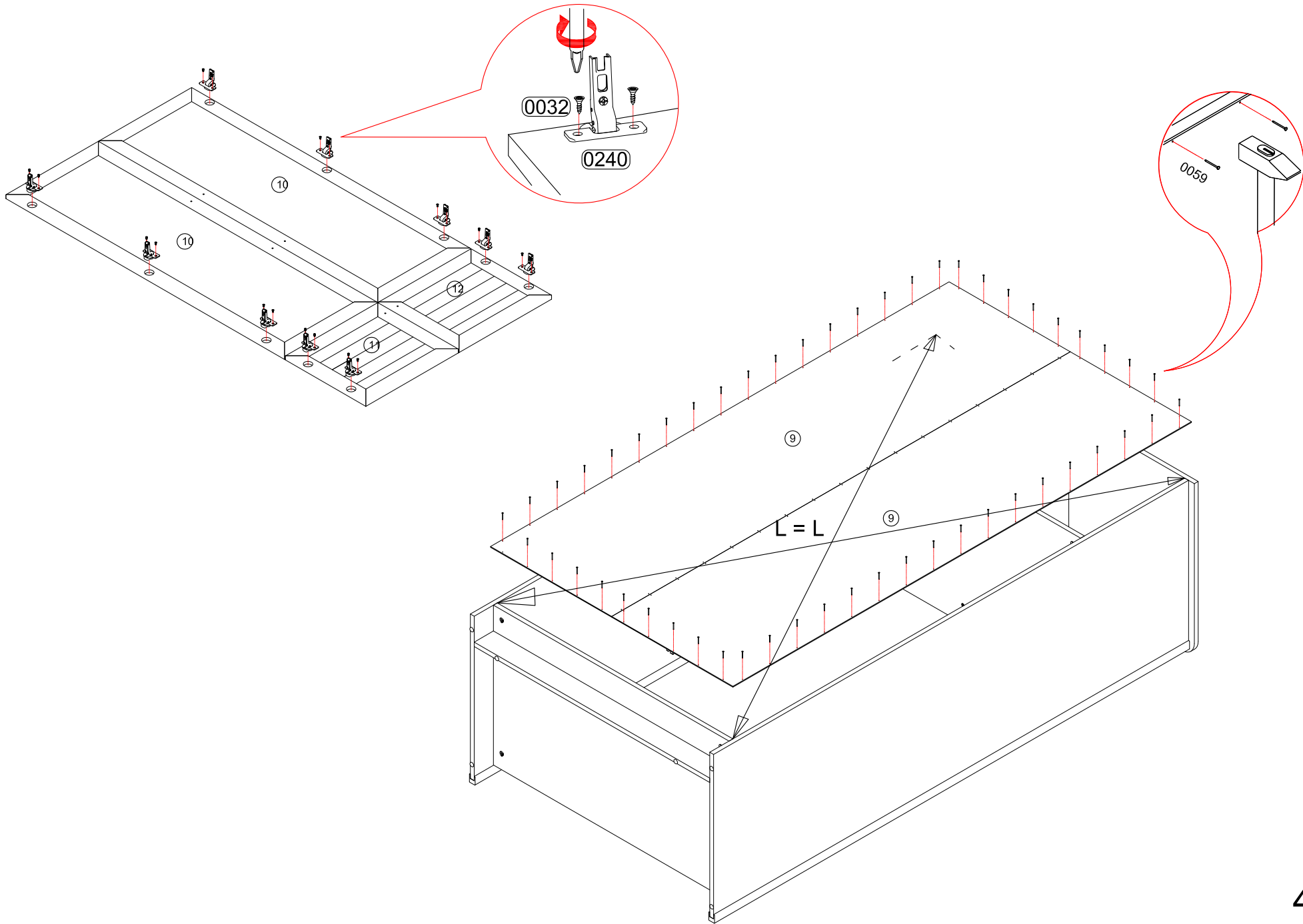

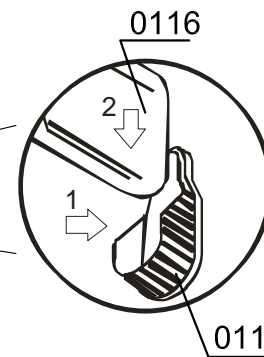
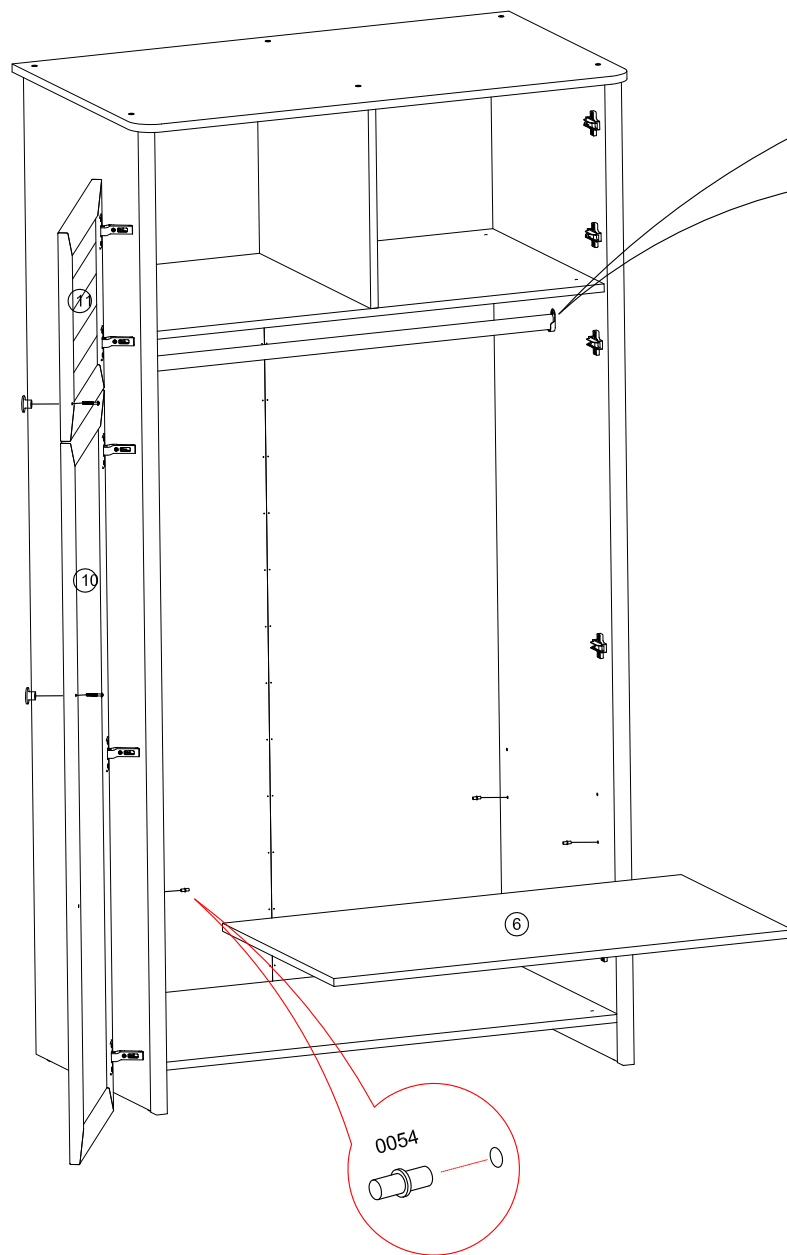
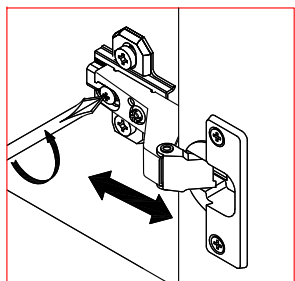
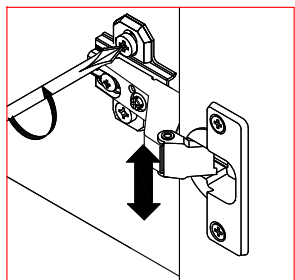
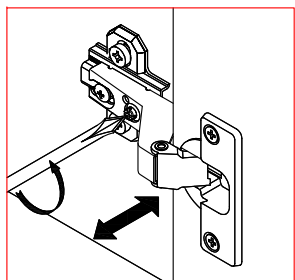

Ø 5скв.  
досверлить

