

Корпус шкафа углового (универсальный)
"МОДЕРН"
СТЛ.322.03

169.^{RU}

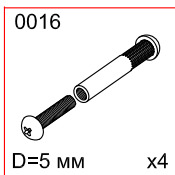
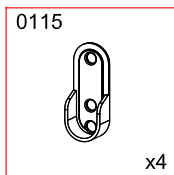
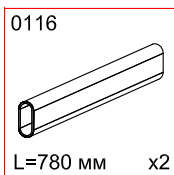
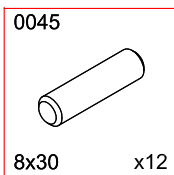
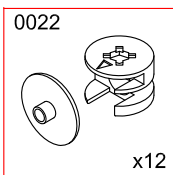
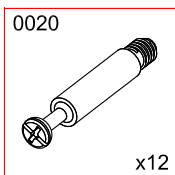
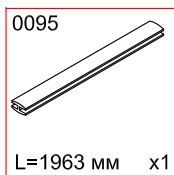
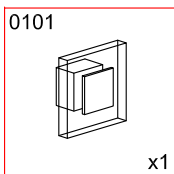
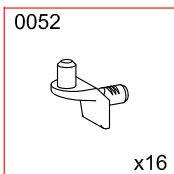
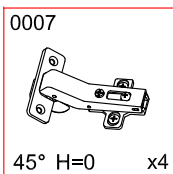
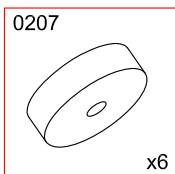
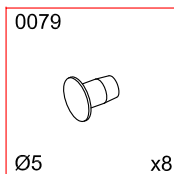
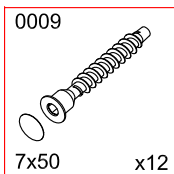
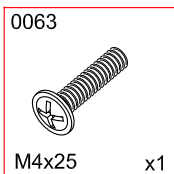
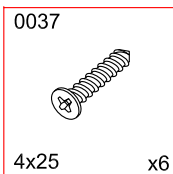
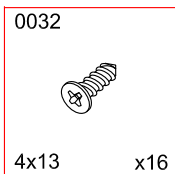
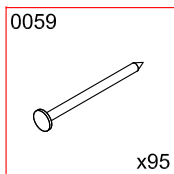
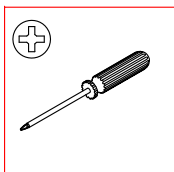
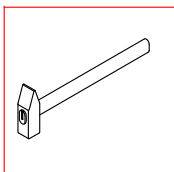
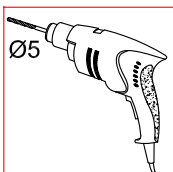
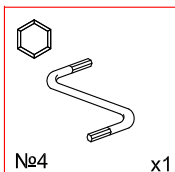
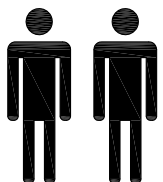

Поз.	Размер	Кол-во	Упаковка
1	546x1998x16	1	пакет 1
2	546x1964x16	1	пакет 1
3	330x1964x16	1	пакет 1
4	450x1998x16	1	пакет 1
5	804x900x16	2	пакет 2

Поз.	Размер	Кол-во	Упаковка
6	1992x406x3	2	пакет 1
7	1992x366x3	1	пакет 1
8	787x220x16	1	пакет 2
9	320x338x16	4	пакет 2

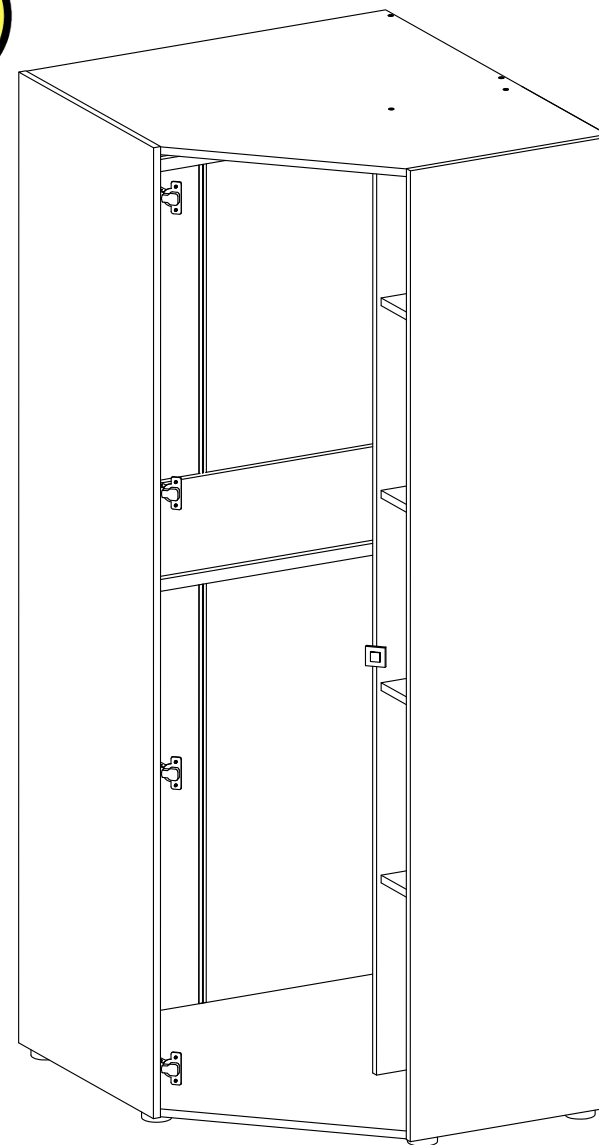
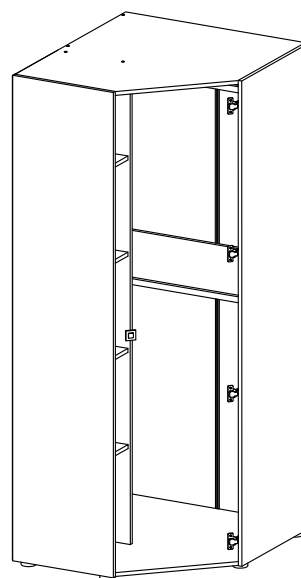

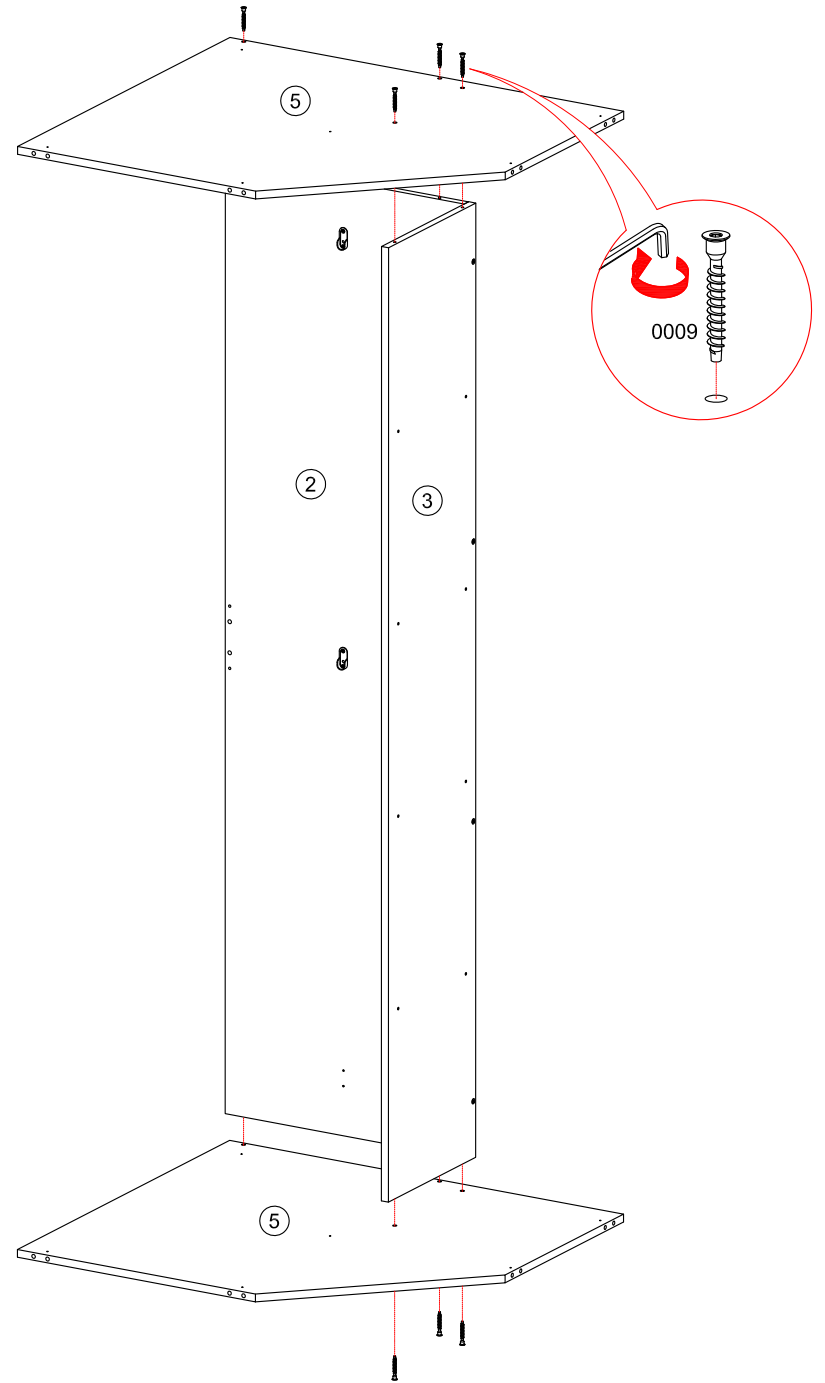
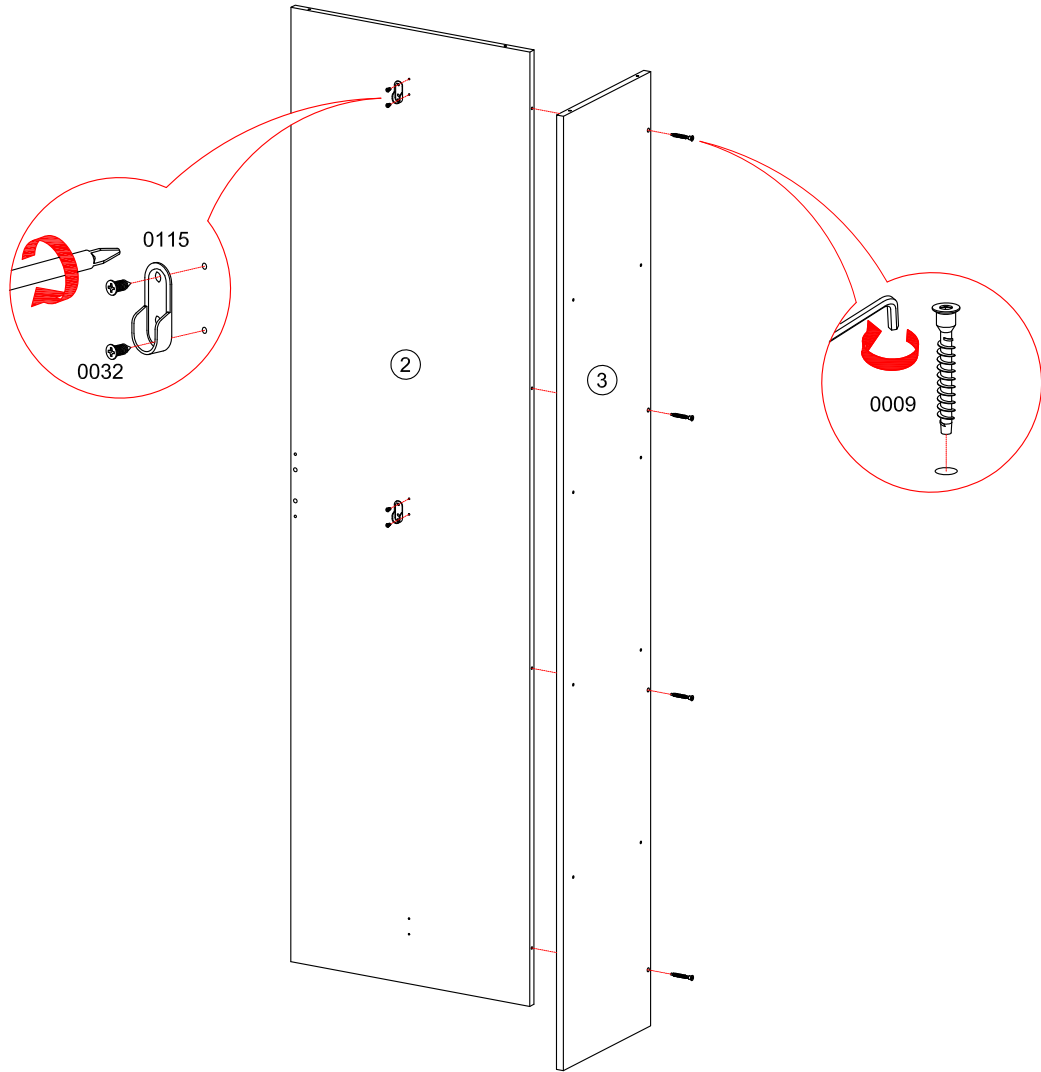
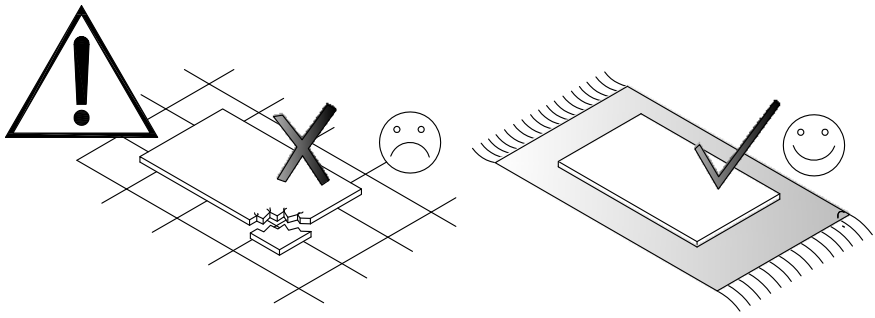

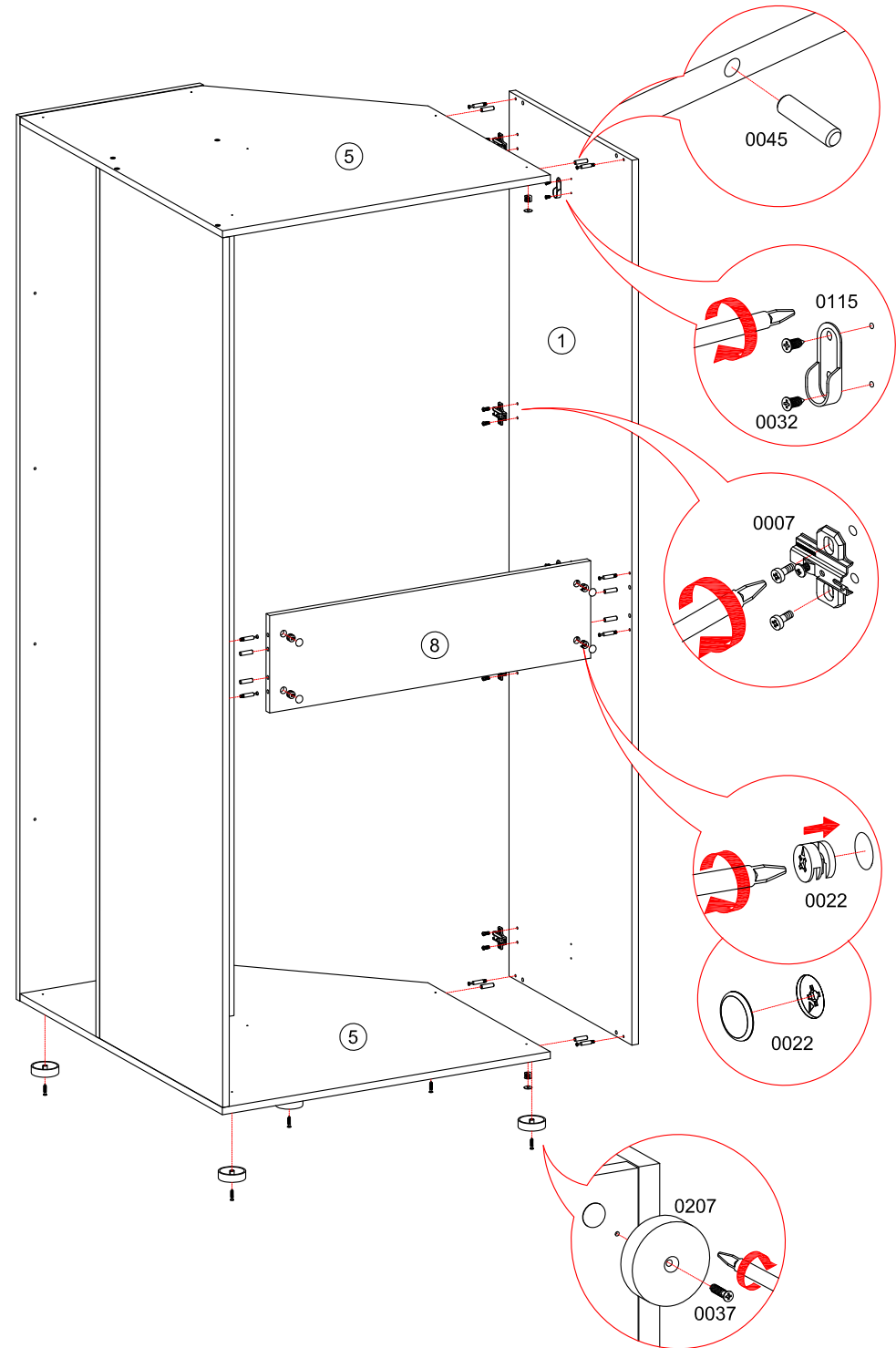
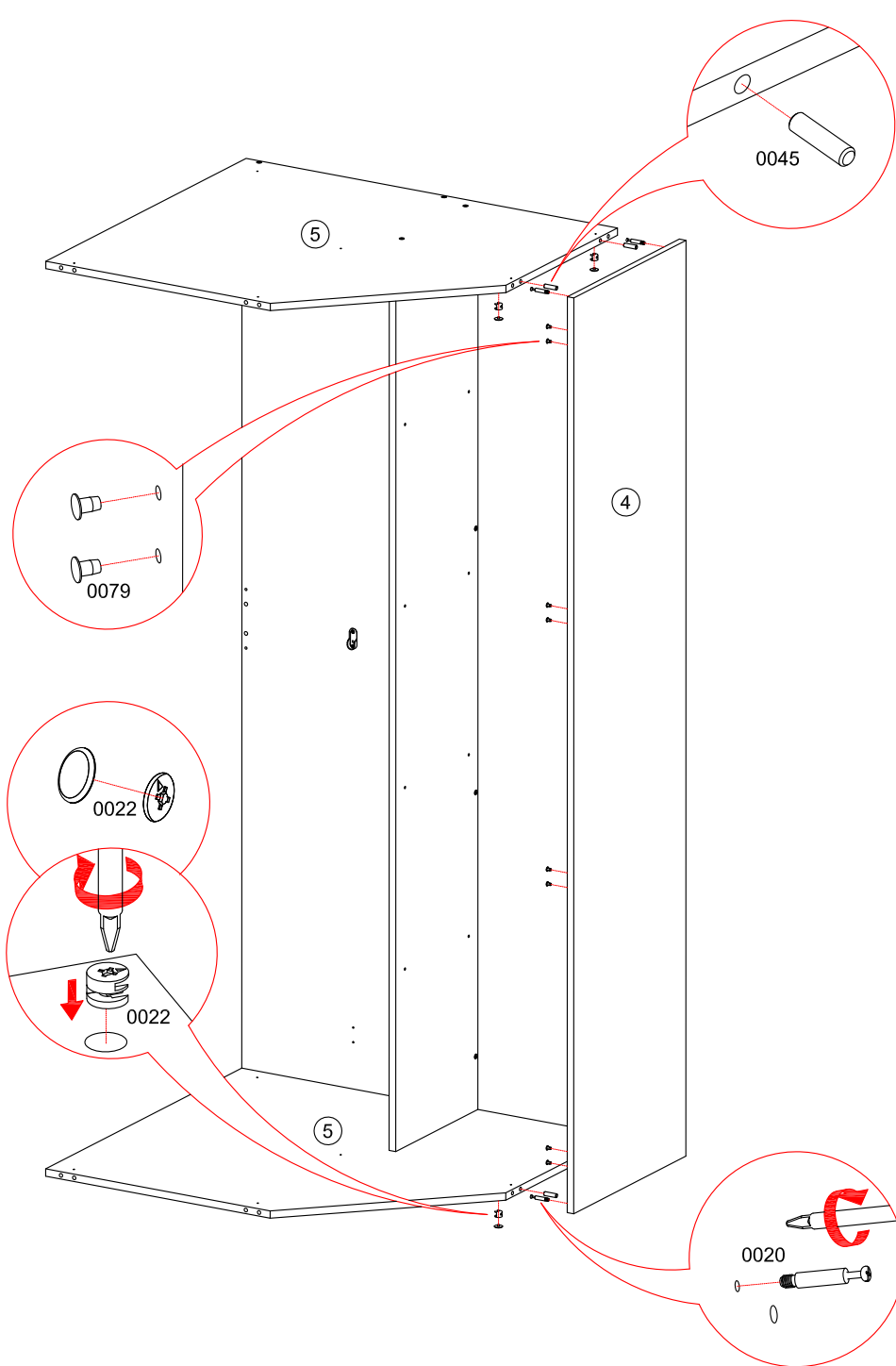

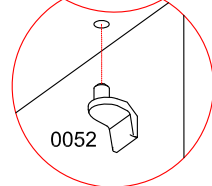
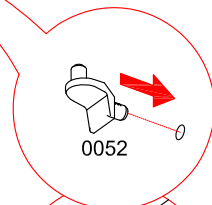
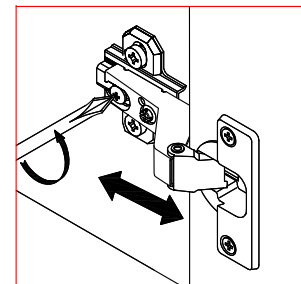
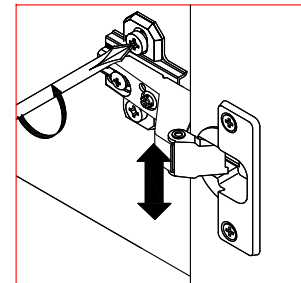
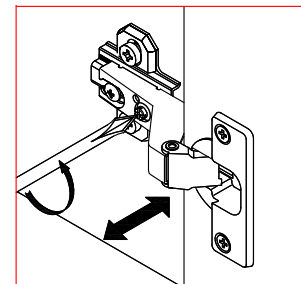
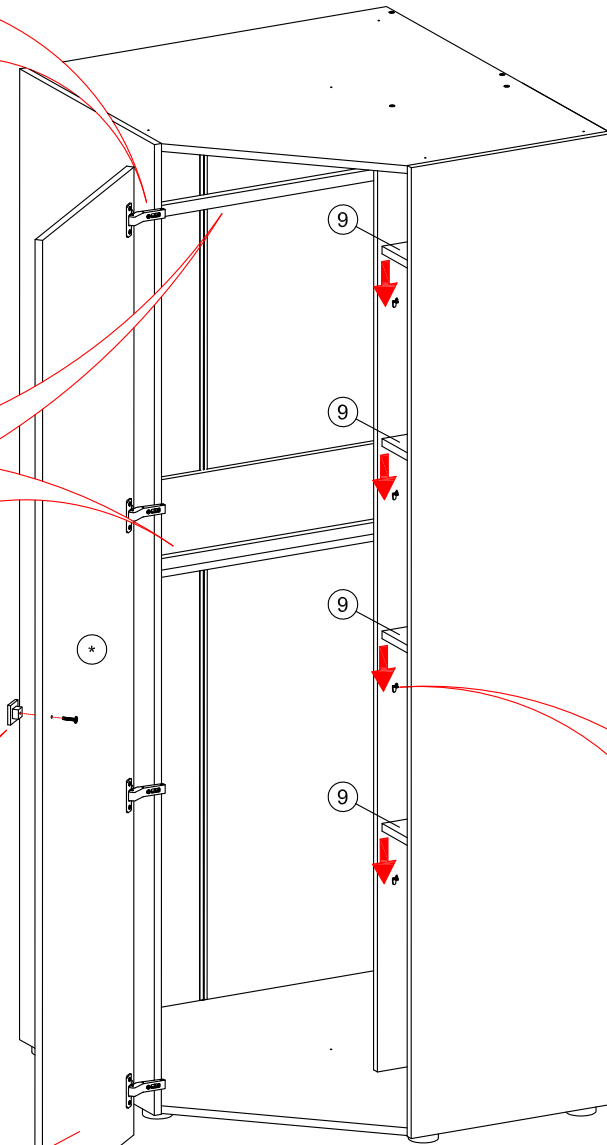
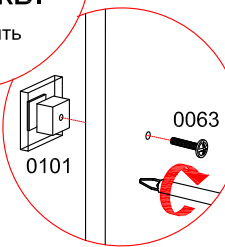
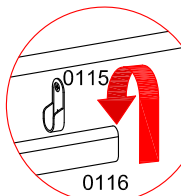
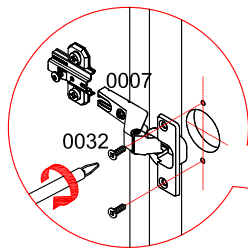
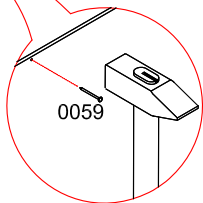
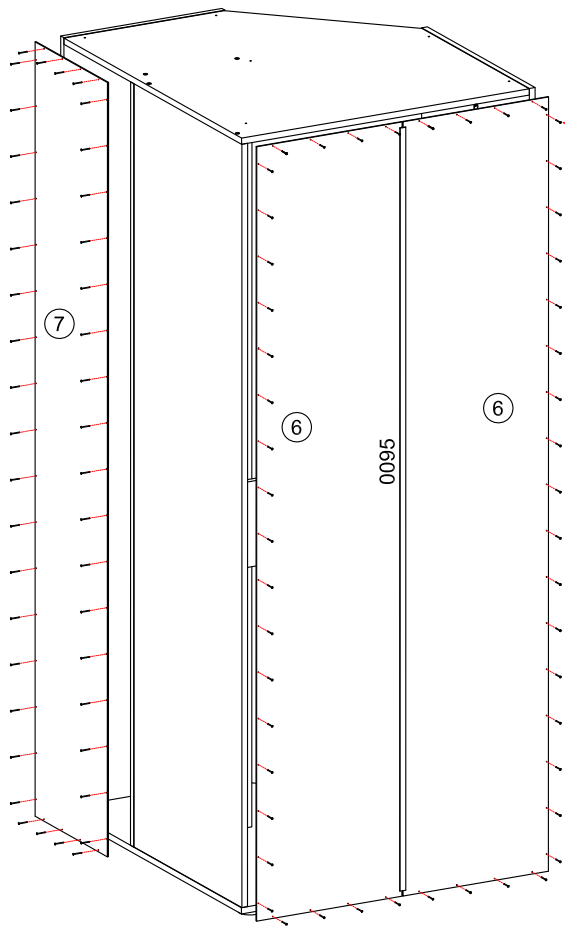

Стяжка 0016 используется для стягивания м/у собой двух корпусов.

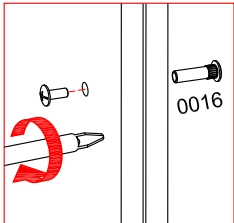
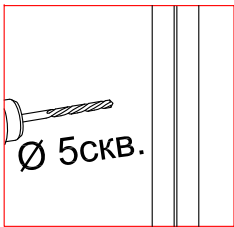

МОДЕРН (СТИЛЬ)	СТЛ.327.01
	СТЛ.327.02
МОДЕРН (ТЕХНО)	СТЛ.328.01
	СТЛ.328.02
МОДЕРН (АБРИС)	СТЛ.329.01

* - Фасад приобретается отдельным комплектом, может быть навешан как на левую, так и на правую боковину шкафа.